

27

Behavioral Ecology

Concept Outline

27.1 Evolutionary forces shape behavior.

Behavioral Ecology. Behavior is shaped by natural selection.

Foraging Behavior. Natural selection favors the most efficient foraging behavior.

Territorial Behavior. Animals defend territory to increase reproductive advantage and foraging efficiency.

27.2 Reproductive behavior involves many choices influenced by natural selection.

Parental Investment and Mate Choice. The degree of parental investment strongly influences other reproductive behaviors.

Reproductive Competition and Sexual Selection. Mate choice affects reproductive success, and so is a target of natural selection.

Mating Systems. Mating systems are reproductive solutions to particular ecological challenges.

27.3 There is considerable controversy about the evolution of social behavior.

Factors Favoring Altruism and Group Living. Many explanations have been put forward to explain the evolution of altruism.

Examples of Kin Selection. One explanation for altruism is that individuals can increase the extent to which their genes are passed on to the next generation by aiding their relatives.

Group Living and the Evolution of Social Systems. Insect societies exhibit extreme cooperation and altruism, perhaps as a result of close genetic relationship of society members.

27.4 Vertebrates exhibit a broad range of social behaviors.

Vertebrate Societies. Many vertebrate societies exhibit altruism.

Human Sociobiology. Human behavior, like that of other vertebrates, is influenced by natural selection.



FIGURE 27.1

A snake in the throes of death—or is it? When threatened, many organisms feign death, as this snake is doing—foaming at the mouth and going limp or looking paralyzed.

Animal behavior can be investigated in a variety of ways. An investigator can ask, how did the behavior develop? What is the physiology behind the behavior? Or what is the function of the behavior (figure 27.1), and does it confer an advantage to the animal? The field of behavioral ecology deals with the last two questions. Specifically, *behavioral ecologists* study the ways in which behavior may be adaptive by allowing an animal to increase or even maximize its reproductive success. This chapter examines both of these aspects of behavioral ecology.

27.1 Evolutionary forces shape behavior.

Behavioral Ecology

In an important essay, Nobel laureate Niko Tinbergen outlined the different types of questions biologists can ask about animal behavior. In essence, he divided the investigation of behavior into the study of its development, physiological basis, and function (evolutionary significance). One type of evolutionary analysis pioneered by Tinbergen himself was the study of the **survival value** of behavior. That is, how does an animal's behavior allow it to stay alive or keep its offspring alive? For example, Tinbergen observed that after gull nestlings hatch, the parents remove the eggshells from the nest. To understand *why* this behavior occurs, he camouflaged chicken eggs by painting them to resemble the natural background where they would lie and distributed them throughout the area in which the gulls were nesting (figure 27.2). He placed broken eggshells next to some of the eggs, and as a control, he left other camouflaged eggs alone without eggshells. He then noted which eggs were found more easily by crows. Because the crows could use the white interior of a broken eggshell as a cue, they ate more of the camouflaged eggs that were near eggshells. Thus, Tinbergen concluded that eggshell removal behavior is *adaptive*: it reduces predation and thus increases the offspring's chances of survival.

Tinbergen is credited with being one of the founders of the field of **behavioral ecology**, the study of how natural selection shapes behavior. This branch of ecology examines the **adaptive significance** of behavior, or how behavior may increase survival and reproduction. Current research in behavioral ecology focuses on the contribution behavior makes to an animal's reproductive success, or **fitness**. As we saw in chapter 26, differences in behavior among individuals often result from genetic differences. Thus, natural selection operating on behavior has the potential to produce evolutionary change. To study the relation between behavior and fitness, then, is to study the process of adaptation itself.

Consequently, the field of behavioral ecology is concerned with two questions. First, is behavior adaptive? Although it is tempting to assume that the behavior produced by individuals must in some way represent an adaptive response to the environment, this need not be the case. As we saw in chapter 20, traits can evolve for many reasons other than natural selection, such as genetic drift or gene flow. Moreover, traits may be present in a population because they evolved as adaptations in the past, but no longer are useful. These possibilities hold true for behavioral traits as much as they do for any other kind of trait.

If a trait is adaptive, the question then becomes: how is it adaptive? Although the ultimate criterion is reproductive



FIGURE 27.2

The adaptive value of egg coloration. Niko Tinbergen painted chicken eggs to resemble the mottled brown camouflage of gull eggs. The eggs were used to test the hypothesis that camouflaged eggs are more difficult for predators to find and thus increase the young's chances of survival.

success, behavioral ecologists are interested in how a trait can lead to greater reproductive success. By enhancing energy intake, thus increasing the number of offspring produced? By improving success in getting more matings? By decreasing the chance of predation? The job of a behavioral ecologist is to determine the effect of a behavioral trait on each of these activities and then to discover whether increases in, for example, foraging efficiency, translate into increased fitness.

Behavioral ecology is the study of how natural selection shapes behavior.

Foraging Behavior

The best introduction to behavioral ecology is the examination of one well-defined behavior in detail. While many behaviors might be chosen, we will focus on foraging behavior. For many animals, food comes in a variety of sizes. Larger foods may contain more energy but may be harder to capture and less abundant. In addition, some types of food may be farther away than other types. Hence, foraging for these animals involves a trade-off between a food's energy content and the cost of obtaining it. The *net energy* (in calories or Joules) gained by feeding on each size prey is simply the energy content of the prey minus the energy costs of pursuing and handling it. According to **optimal foraging theory**, natural selection favors individuals whose foraging behavior is as energetically efficient as possible. In other words, animals tend to feed on prey that maximize their net energy intake per unit of foraging time.

A number of studies have demonstrated that foragers do preferentially utilize prey that maximize the energy return. Shore crabs, for example, tend to feed primarily on intermediate-sized mussels which provide the greatest energetic return; larger mussels provide more energy, but also take considerably more energy to crack open (figure 27.3).

This optimal foraging approach makes two assumptions. First, natural selection will only favor behavior that maximizes energy acquisition if increased energy reserves lead to increases in reproductive success. In some cases, this is true. For example, in both Columbian ground squirrels and captive zebra finches, a direct relationship exists between net energy intake and the number of offspring raised; similarly, the reproductive success of orb-weaving spiders is related to how much food they can capture.

However, animals have other needs beside energy acquisition, and sometimes these needs come in conflict. One obvious alternative is avoiding predators: oftentimes the behavior that maximizes energy intake is not the one that minimizes predation risk. Thus, the behavior that maximizes fitness often may reflect a trade-off between obtaining the most energy at the least risk of being eaten. Not surprisingly, many studies have shown that a wide variety of animal species alter their foraging behavior when predators are present. Still another alternative is finding mates: males of many species, for example, will greatly reduce their feeding rate in order to enhance their ability to attract and defend females.

The second assumption of optimal foraging theory is that it has resulted from natural selection. As we have seen, natural selection can lead to evolutionary change only when differences among individuals have a genetic basis. Few studies have investigated whether differences among individuals in their ability to maximize energy in-

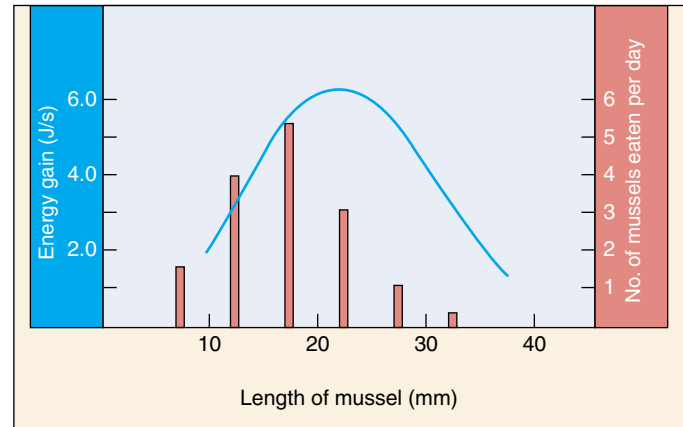

FIGURE 27.3

Optimal diet. The shore crab selects a diet of energetically profitable prey. The curve describes the net energy gain (equal to energy gained minus energy expended) derived from feeding on different sizes of mussels. The bar graph shows the numbers of mussels of each size in the diet. Shore crabs most often feed on those mussels that provide the most energy.

take is the result of genetic differences, but there are some exceptions. For example, one study found that female zebra finches that were particularly successful in maximizing net energy intake tended to have offspring that were similarly successful. Because birds were removed from their mothers before they left the nest, this similarity likely reflected a genetic basis for foraging behavior, rather than being a result of young birds learning to forage from their mothers.

Differences among individuals in foraging behavior may also be a function of age. Inexperienced yellow-eyed juncos (a small North American bird), for example, have not learned how to handle large prey items efficiently. As a result, the energetic costs of eating such prey are higher than the benefits, and as a result they tend to focus on smaller prey. Only when the birds are older and more experienced do they learn to easily dispatch these prey, which are then included in the diet.

Natural selection may favor the evolution of foraging behaviors that maximize the amount of energy gained per unit time spent foraging. Animals that acquire energy efficiently during foraging may increase their fitness by having more energy available for reproduction, but other considerations, such as avoiding predators, also are important in determining reproductive success.

Territorial Behavior

Animals often move over a large area, or **home range**, during their daily course of activity. In many animal species, the home ranges of several individuals may overlap in time or in space, but each individual defends a *portion* of its home range and uses it *exclusively*. This behavior, in which individual members of a species maintain exclusive use of an area that contains some limiting resource, such as foraging ground, food, or potential mates, is called **territoriality** (figure 27.4). The critical aspect of territorial behavior is *defense* against intrusion by other individuals. Territories are defended by displays that advertise that the territories are occupied and by overt aggression. A bird sings from its perch within a territory to prevent a takeover by a neighboring bird. If an intruder is not deterred by the song, it may be attacked. However, territorial defense has its costs. Singing is energetically expensive, and attacks can lead to injury. In addition, advertisement through song or visual display can reveal one's position to a predator.

Why does an animal bear the costs of territorial defense? Over the past two decades, it has become increasingly clear that an *economic* approach can be useful in answering this question. Although there are costs to defending a territory, there are also benefits; these benefits may take the form of increased food intake, exclusive access to mates, or access to refuges from predators. Studies of nectar-feeding birds like hummingbirds and sunbirds provide an example (figure 27.5). A bird benefits from having the exclusive use of a patch of flowers because it can efficiently harvest the nectar they produce. In order to maintain exclusive use, however, the bird must actively defend the flowers. The benefits of exclusive use outweigh the costs of defense only under certain conditions. Sunbirds, for example, expend 3000 calories per hour chasing intruders from a territory. Whether or not the benefit of defending a territory will exceed this cost depends upon the amount of nectar in the flowers and how efficiently the bird can collect it. If flowers are very scarce or nectar levels are very low, for example, a nectar-feeding bird may not gain enough energy to balance the energy used in defense. Under this circumstance, it is not advantageous to be territorial. Similarly, if flowers are very abundant, a bird can efficiently meet its daily energy requirements without behaving territorially and adding the costs of defense. From an energetic standpoint, defending abundant resources isn't worth the cost. Territoriality thus only occurs at intermediate levels of flower availability and higher levels of nectar production, where the benefits of defense outweigh the costs.

In many species, exclusive access to females is a more important determinant of territory size of males than is food availability. In some lizards, for example, males maintain enormous territories during the breeding season. These territories, which encompass the territories of

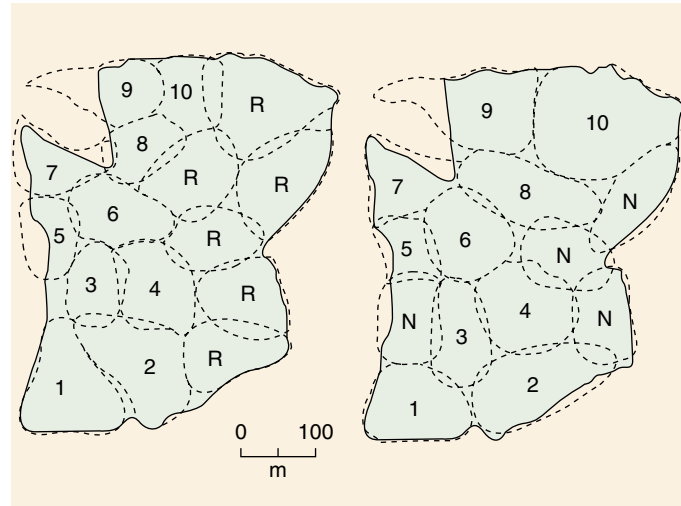

FIGURE 27.4

Competition for space. Territory size in birds is adjusted according to the number of competitors. When six pairs of great tits (*Parus major*) were removed from their territories (indicated by R in the left figure), their territories were taken over by other birds in the area and by four new pairs (indicated by N in the right figure). Numbers correspond to the birds present before and after.



FIGURE 27.5

The benefit of territoriality. Sunbirds increase nectar availability by defending flowers.

several females, are much larger than what is required to supply enough food and are defended vigorously. In the nonbreeding season, by contrast, male territory size decreases dramatically, as does aggressive territorial behavior.

An economic approach can be used to explain the evolution and ecology of reproductive behaviors such as territoriality. This approach assumes that animals that gain more energy from a behavior than they expend will have an advantage in survival and reproduction over animals that behave in less efficient ways.

27.2 Reproductive behavior involves many choices influenced by natural selection.

Searching for a place to nest, finding a mate, and rearing young involve a collection of behaviors loosely referred to as reproductive behavior. These behaviors often involve seeking and defending a particular territory, making choices about mates and about the amount of energy to devote to the rearing of young. Mate selection, in particular, often involves intense natural selection. We will look briefly at each of these components of reproductive behavior.

During the breeding season, animals make several important “decisions” concerning their choice of mates, how many mates to have, and how much time and energy to devote to rearing offspring. These decisions are all aspects of an animal’s **reproductive strategy**, a set of behaviors that presumably have evolved to maximize reproductive success. Reproductive strategies have evolved partly in response to the energetic costs of reproduction and the way food resources, nest sites, and members of the opposite sex are spatially distributed in the environment.

Parental Investment and Mate Choice

Males and females usually differ in their reproductive strategies. Darwin was the first to observe that females often do not simply mate with the first male they encounter, but instead seem to evaluate a male’s quality and then decide whether to mate. This behavior, called **mate choice**, has since been described in many invertebrate and vertebrate species.

By contrast, mate choice by males is much less common. Why should this be? Many of the differences in reproductive strategies between the sexes can be understood by comparing the parental investment made by males and females. **Parental investment** refers to the contributions each sex makes in producing and rearing offspring; it is, in effect, an estimate of the energy expended by males and females in each reproductive event.

Many studies have shown that parental investment is high in females. One reason is that eggs are much larger than sperm—195,000 times larger in humans! Eggs contain proteins and lipids in the yolk and other nutrients for the developing embryo, but sperm are little more than mobile DNA. Furthermore, in some groups of animals, females are responsible for gestation and lactation, costly reproductive functions only they can carry out.

The consequence of such great disparities in reproductive investment is that the sexes should face very different selective pressures. Because any single reproductive event is relatively cheap for males, they can best increase their fitness by mating with as many females as possible—male fit-



FIGURE 27.6

The advantage of male mate choice. Male mormon crickets choose heavier females as mates, and larger females have more eggs. Thus, male mate selection increases fitness.

ness is rarely limited by the amount of sperm they can produce. By contrast, each reproductive event for females is much more costly and the number of eggs that can be produced often does limit reproductive success. For this reason, females have an incentive to be choosy, trying to pick the male they can provide the greatest benefit to her offspring. As we shall see, this benefit can take a number of different forms.

These conclusions only hold when female reproductive investment is much greater than that of males. In species with parental care, males may contribute equally to the cost of raising young; in this case, the degree of mate choice should be equal between the sexes.

Furthermore, in some cases, male investment exceeds that of females. For example, male mormon crickets transfer a protein-containing spermatophore to females during mating. Almost 30% of a male’s body weight is made up by the spermatophore, which provides nutrition for the female, and helps her develop her eggs. As one might expect, in this case it is the females that compete with each other for access to males, and the males that are the choosy sex. Indeed, males are quite selective, favoring heavier females. The selective advantage of this strategy results because heavier females have more eggs; thus, males that choose larger females leave more offspring (figure 27.6).

Reproductive investment by the sexes is strongly influenced by differences in the degree of parental investment.

Reproductive Competition and Sexual Selection

In chapter 20, we learned that the reproductive success of an individual is determined by a number of factors: how long the individual lives, how successful it is in obtaining matings, and how many offspring it produces per mating. The second of these factors, competition for mating opportunities, has been termed **sexual selection**. Some people consider sexual selection to be distinctive from natural selection, but others see it as a subset of natural selection, just one of a number of ways in which organisms can increase their fitness.

Sexual selection involves both **intrasexual selection**, or interactions between members of one sex (“the power to conquer other males in battle,” as Darwin put it), and **intersexual selection**, essentially mate choice (“the power to charm”). Sexual selection thus leads to the evolution of structures used in combat with other males, such as a deer’s antlers and a ram’s horns, as well as ornamentation used to “persuade” members of the opposite sex to mate, such as long tail feathers and bright plumage (figure 27.7*a*). These traits are called **secondary sexual characteristics**.

Intrasexual Selection

In many species, individuals of one sex—usually males—compete with each other for the opportunity to mate with individuals of the other sex. These competitions may take place over ownership of a territory in which females reside or direct control of the females themselves. The latter case is exemplified by many species, such as impala, in which fe-

males travel in large groups with a single male that gets exclusive rights to mate with the females and thus strives vigorously to defend these rights against other males which would like to supplant him.

In mating systems such as these, a few males may get an inordinate number of matings and most males do not mate at all. In elephant seals, in which males control territories on the breeding beaches, a few dominant males do most of the breeding. On one beach, for example, eight males impregnated 348 females, while the remaining males got very little action (or, we could say, while the remaining males mated rarely, if at all).

For this reason, selection will strongly favor any trait that confers greater ability to outcompete other males. In many cases, size determines mating success: the larger male is able to dominate the smaller one. As a result, in many territorial species, males have evolved to be considerably larger than females, for the simple reason that the largest males are the ones that get to mate. Such differences between the sexes are referred to as **sexual dimorphism**. In other species, males have evolved structures used for fighting, such as horns, antlers, and large canine teeth. These traits are also often sexually dimorphic and may have evolved because of the advantage they give in intrasexual conflicts.

Intersexual Selection

Peahens prefer to mate with peacocks that have more spots in their long tail feathers (figure 27.7*b,c*). Similarly, female frogs prefer to mate with males with more complex calls. Why did such mating preferences evolve?

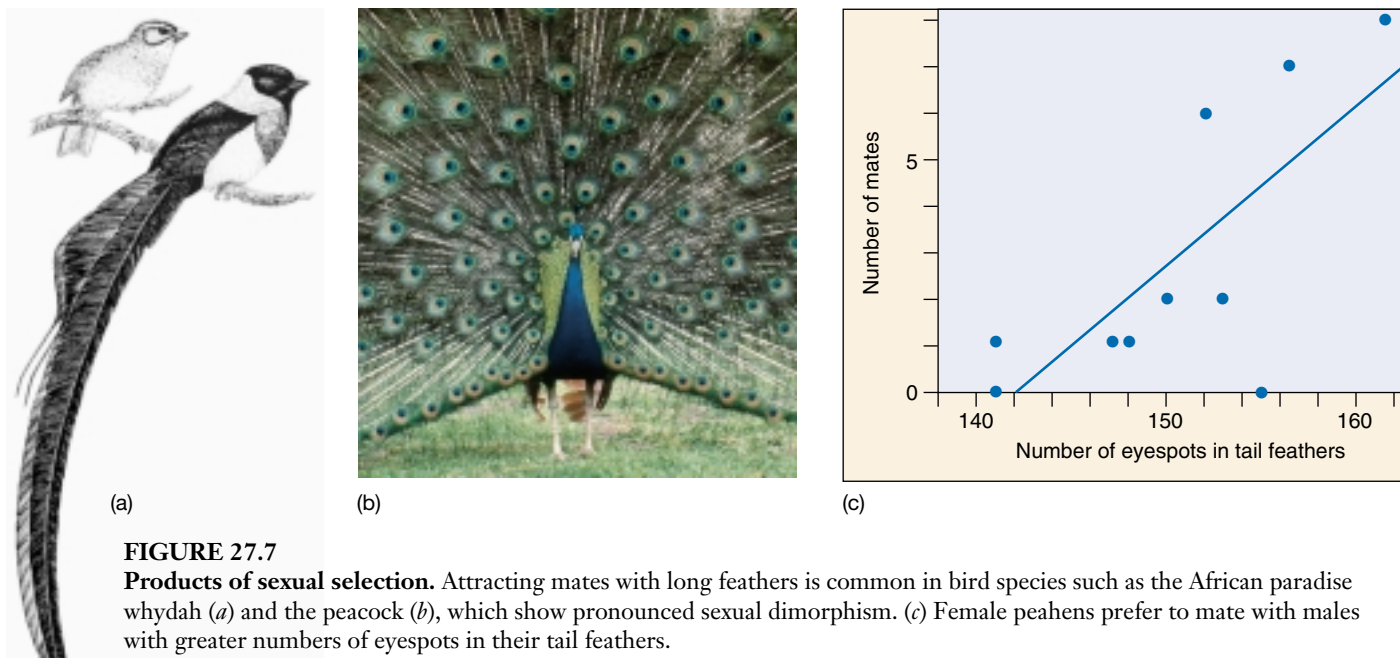

FIGURE 27.7

Products of sexual selection. Attracting mates with long feathers is common in bird species such as the African paradise whydah (*a*) and the peacock (*b*), which show pronounced sexual dimorphism. (*c*) Female peahens prefer to mate with males with greater numbers of eyespots in their tail feathers.

The Benefits of Mate Choice

In some cases, the benefits are obvious. In many species of birds and mammals, and some species of other types of animals, males help raise the offspring. In these cases, females would benefit by choosing the male that can provide the best care—the better the parent, the more offspring she is likely to rear.

In other species, males provide no care, but maintain territories that provide food, nesting sites, and predator refuges. In such species, females that choose males with the best territories will maximize their reproductive success.

Indirect Benefits

In other species, however, males provide no direct benefits of any kind to females. In such cases, it is not intuitively obvious what females have to gain by being choosy. Moreover, what could be the possible benefit of choosing a male with an extremely long tail or a complex song?

A number of theories have been proposed to explain the evolution of such preferences. One idea is that females choose the male that is the healthiest or oldest. Large males, for example, have probably been successful at living long, acquiring a lot of food and resisting parasites and disease. Similarly, in guppies and some birds, the brightness of a male's color is a reflection of the quality of his diet and overall health. Females may gain two benefits from mating with large or colorful males. First, to the extent that the males' success in living long and prospering is the result of a good genetic makeup, the female will be ensuring that her offspring receive good genes from their father. Indeed, several studies have demonstrated that males that are preferred by females produce offspring that are more vigorous and survive better than offspring of males that are not preferred. Second, healthy males are less likely to be carrying diseases, which might be transmitted to the female during mating.

A variant of this theory goes one step further. In some cases, females prefer mates with traits that are detrimental to survival (figure 27.8). The long tail of the peacock is a hindrance in flying and makes males more vulnerable to predators. Why should females prefer males with such traits? The **handicap hypothesis** states that only genetically superior mates can survive with such a handicap. By choosing a male with the largest handicap, the female is ensuring that her offspring will receive these quality genes. Of course, the male offspring will also inherit the genes for the handicap. For this reason, evolutionary biologists are still debating the merits of this hypothesis.

Other courtship displays appear to have evolved from a predisposition in the female's sensory system to be stimulated by a certain type of stimulus. For example, females may be better able to detect particular colors or sounds at a certain frequency. Sensory exploitation involves the evolution in males of an attractive signal that “exploits” these

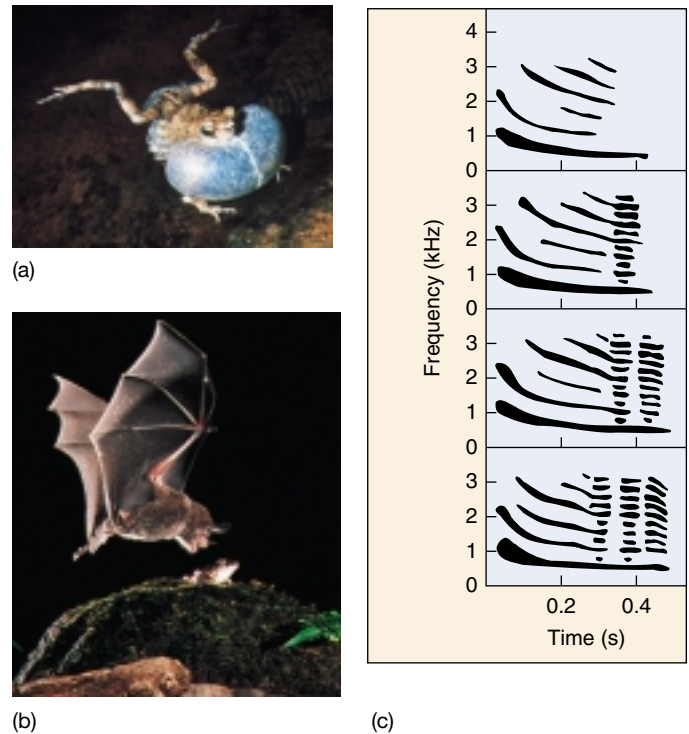

FIGURE 27.8
The benefits and costs of vocalizing. (a) The male Túngara frog, *Physalaemus pustulosus*. (b) The males' calls attract females as well as predatory bats. Calls of greater complexity are represented from top to bottom in (c). Females prefer more complex calls, but these calls are detected particularly well by bats. Consequently, males that females prefer are at the greatest risk of being captured.

preexisting biases—if females are particularly adept at detecting red objects, for example, then males will evolve red coloration. Consider the vocalizations of the Túngara frog (*Physalaemus pustulosus*) (see figure 27.8). Unlike related species, males include a “chuck” in their calls. Recent research suggests that even females of related species are particularly attracted to calls of this sort, even though males of these species do not produce “chucks.” Why this preference evolved is unknown, but males of the Túngara frog have evolved to take advantage of it.

A great variety of other theories have been proposed to explain the evolution of mating preferences. Many of these theories may be correct in some circumstances and none seems capable of explaining all of the variation in mating behavior in the animal world. This is an area of vibrant research with new discoveries appearing regularly.

Natural selection has favored the evolution of behaviors that maximize the reproductive success of males and females. By evaluating and selecting mates with superior qualities, an animal can increase its reproductive success.

Mating Systems

The number of individuals with which an animal mates during the breeding season varies throughout the animal kingdom. Mating systems such as monogamy (one male mates with one female); polygyny (one male mates with more than one female; figure 27.9), and polyandry (one female mates with more than one male) are aspects of male and female reproductive strategy that concern how many mates an individual has during the breeding season. Like mate choice, mating systems have evolved to maximize reproductive fitness. Much research has shown that mating systems are strongly influenced by ecology. For instance, a male may defend a territory that holds nest sites or food sources necessary for a female to reproduce, and the territory might have resources sufficient for more than one female. If males differ in the quality of the territories they hold, a female's fitness will be maximized if she mates with a male holding a high-quality territory. Such a male may already have a mate, but it is still more advantageous for the female to breed with that male than with an unmated male that defends a low-quality territory. In this way, natural selection would favor the evolution of polygyny.

Mating systems are also constrained by the needs of offspring. If the presence of both parents is necessary for young to be reared successfully, then monogamy may be favored. This is generally the case in birds, in which over 90% of all species are monogamous. A male may either remain with his mate and provide care for the offspring or desert that mate to search for others; both strategies may increase his fitness. The strategy that natural selection will favor depends upon the requirement for male assistance in feeding or defending the offspring. In some species, offspring are **altricial**—they require prolonged and extensive care. In these species, the need for care by two parents will reduce the tendency for the male to desert his mate and seek other matings. In species where the young are **precocial** (requiring little parental care), males may be more likely to be polygynous.

Although polygyny is much more common, polyandrous systems—in which one female mates with several males—are known in a variety of animals. For example, in spotted sandpipers, males take care of all incubation and parenting, and females mate and leave eggs with two or more males.

In recent years, researchers have uncovered many unexpected aspects of animal reproductive systems. Some of these discoveries have resulted from the application of new technologies, whereas others have come from detailed and intensive field studies.

Extra-Pair Copulations

In chapter 19, we saw how DNA fingerprinting can be used to identify blood samples. Another common use of this technology is to establish paternity. DNA fingerprints are



FIGURE 27.9
Female defense polygyny in bats. The male at the lower right is guarding a group of females.

so variable that each individual's is unique. Thus, by comparing the DNA of a man and a child, experts can establish with a relatively high degree of confidence whether the man is the child's father.

This approach is now commonly used in paternity lawsuits, but it has also become a standard weapon in the arsenal of behavioral ecologists. By establishing paternity, researchers can precisely quantify the reproductive success of individual males and thus assess how successful their particular reproductive strategies have been (figure 27.10a). In one classic study of red-winged blackbirds (figure 27.10b), researchers established that half of all nests contained at least one bird fertilized by a male other than the territory owner; overall, 20% of the offspring were the result of such **extra-pair copulations** (EPCs).

Studies such as this have established that EPCs—"cheating"—are much more pervasive in the bird world than originally suspected. Even in some species that were believed to be monogamous on the basis of behavioral observations, the incidence of offspring being fathered by a male other than the female's mate is sometimes surprisingly high.

Why do individuals have extra-pair copulations? For males, the answer is obvious: increased reproductive success. For females, it is less clear, as in most cases, it does not result in an increased number of offspring. One possi-

bility is that females mate with genetically superior individuals, thus enhancing the genes passed on to their offspring. Another possibility is that females can increase the amount of help they get in raising their offspring. If a female mates with more than one male, each male may help raise the offspring. This is exactly what happens in a common English bird, the dunnock. Females mate not only with the territory owner, but also with subordinate males that hang around the edge of the territory. If these subordinates mate enough with a female, they will help raise her young, presumably because some of these young may have been fathered by this male.

Alternative Mating Tactics

Natural selection has led to the evolution of a variety of other means of increasing reproductive success. For example, in many species of fish, there are two genetic classes of males. One group is large and defends territories to obtain matings. The other type of male is small and adopts a completely different strategy. They do not maintain territories, but hang around the edge of the territories of large males. Just at the end of a male's courtship, when the female is laying her eggs and the territorial male is depositing sperm, the smaller male will dart in and release its own sperm into the water, thus fertilizing some of the eggs. If this strategy is successful, natural selection will favor the evolution of these two different male reproductive strategies.

Similar patterns are seen in other organisms. In some dung beetles, territorial males have large horns that they use to guard the chambers in which females reside, whereas genetically small males don't have horns; instead, they dig side tunnels and attempt to intercept the female inside her chamber. In isopods, there are three genetic size classes. The medium-sized males pass for females and enter a large male's territory in this way; the smallest class are so tiny, they are able to sneak in completely undetected.

This is just a glimpse of the rich diversity in mating systems that have evolved. The bottom line is: if there is a way of increasing reproductive success, natural selection will favor its evolution.

Mating systems represent reproductive adaptations to ecological conditions. The need for parental care, the ability of both sexes to provide it, and the timing of female reproduction are important influences on the evolution of monogamy, polygyny, and polyandry. Detailed study of animal mating systems, along with the use of modern molecular techniques, are revealing many surprises in animal mating systems. This diversity is a testament to the power of natural selection to favor any trait that increases an animal's fitness.

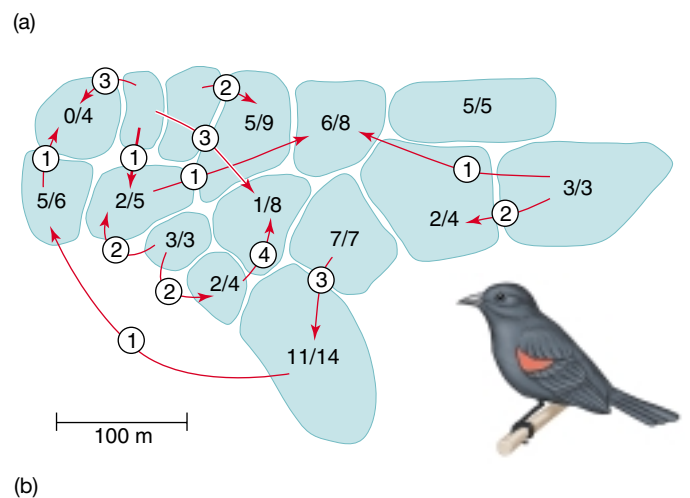
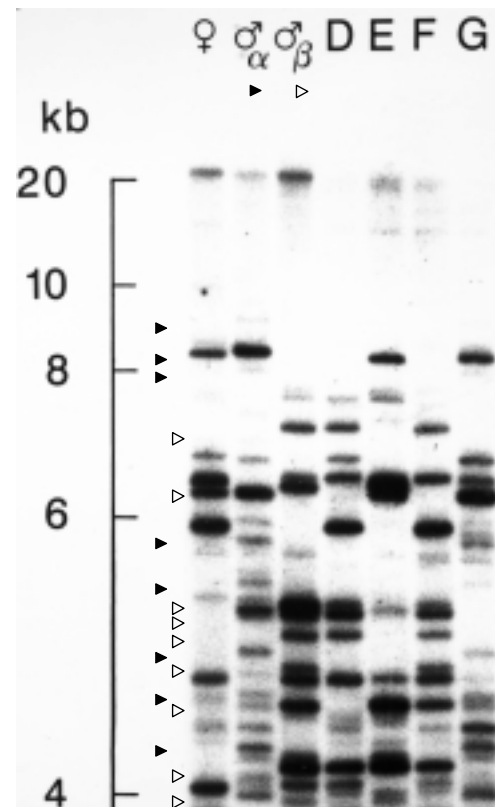

FIGURE 27.10
The study of paternity. (a) A DNA fingerprinting gel from the dunnock. The bands represent fragments of DNA of different lengths. The four nestlings (D-G) were in the nest of the female. By comparing the bands present in the two males, we can determine which male fathered which offspring. The triangles point to the bands which are diagnostic for one male and not the other. In this case, the beta male fathered three of the four offspring. (b) Results of a DNA fingerprinting study in red-winged blackbirds. Fractions indicate the proportion of offspring fathered by the male in whose territory the nest occurred. Arrows indicate how many offspring were fathered by particular males outside of each territory. Nests on some territories were not sampled.

27.3 There is considerable controversy about the evolution of social behavior.

Factors Favoring Altruism and Group Living

Altruism—the performance of an action that benefits another individual at a cost to the actor—occurs in many guises in the animal world. In many bird species, for example, parents are assisted in raising their young by other birds, which are called **helpers at the nest**. In species of both mammals and birds, individuals that spy a predator will give an alarm call, alerting other members of their group, even though such an act would seem to call the predator’s attention to the caller. Finally, lionesses with cubs will allow all cubs in the pride to nurse, including cubs of other females.

The existence of altruism has long perplexed evolutionary biologists. If altruism imposes a cost to an individual, how could an allele for altruism be favored by natural selection? One would expect such alleles to be at a disadvantage and thus their frequency in the gene pool should decrease through time.

A number of explanations have been put forward to explain the evolution of altruism. One suggestion often heard on television documentaries is that such traits evolve for the good of the species. The problem with such explanations is that natural selection operates on individuals within species, not on species themselves. Thus, it is even possible for traits to evolve that are detrimental to the species as a whole, as long as they benefit the individual. In some cases, selection can operate on groups of individuals, but this is rare. For example, if an allele for supercannibalism evolved within a population, individuals with that allele would be favored, as they would have more to eat; however, the group might eventually eat itself to extinction, and the allele would be removed from the species. In certain circumstances, such **group selection** can occur, but the conditions for it to occur are rarely met in nature. In most cases, consequently, the “good of the species” cannot explain the evolution of altruistic traits.

Another possibility is that seemingly altruistic acts aren’t altruistic after all. For example, helpers at the nest are often young and gain valuable parenting experience by assisting established breeders. Moreover, by hanging around an area, such individuals may inherit the territory when the established breeders die. Similarly, alarm callers may actually be beneficial by causing other animals to panic. In the ensuing confusion, the caller may be able to slip off undetected. Detailed field studies in recent years have demonstrated that some acts truly are altruistic, but others are not as they seemed.

Reciprocity

Robert Trivers, now of Rutgers University, proposed that individuals may form “partnerships” in which mutual exchanges of altruistic acts occur, because it benefits both participants to do so. In the evolution of such **reciprocal altruism**, “cheaters” (nonreciprocators) are discriminated against and are cut off from receiving future aid. According to Trivers, if the altruistic act is relatively inexpensive, the small benefit a cheater receives by not reciprocating is far outweighed by the potential cost of not receiving future aid. Under these conditions, cheating should not occur.

Vampire bats roost in hollow trees in groups of 8 to 12 individuals. Because these bats have a high metabolic rate, individuals that have not fed recently may die. Bats that have found a host imbibe a great deal of blood; giving up a small amount presents no great energy cost to the donor, and it can keep a roostmate from starvation. Vampire bats tend to share blood with past reciprocators. If an individual fails to give blood to a bat from which it had received blood in the past, it will be excluded from future bloodsharing.

Kin Selection

The most influential explanation for the origin of altruism was presented by William D. Hamilton in 1964. It is perhaps best introduced by quoting a passing remark made in a pub in 1932 by the great population geneticist J. B. S. Haldane. Haldane said that he would willingly lay down his life for *two brothers* or *eight first cousins*. Evolutionarily speaking, Haldane’s statement makes sense, because for each allele Haldane received from his parents, his brothers each had a 50% chance of receiving the same allele (figure 27.11). Consequently, it is statistically expected that two of his brothers would pass on as many of Haldane’s particular combination of alleles to the next generation as Haldane himself would. Similarly, Haldane and a first cousin would share an eighth of their alleles (see figure 27.11). Their parents, which are siblings, would each share half their alleles, and each of their children would receive half of these, of which half on the average would be in common: one-half \times one-half \times one-half = one-eighth. Eight first cousins would therefore pass on as many of those alleles to the next generation as Haldane himself would. Hamilton saw Haldane’s point clearly: natural selection will favor any strategy that increases the net flow of an individual’s alleles to the next generation.

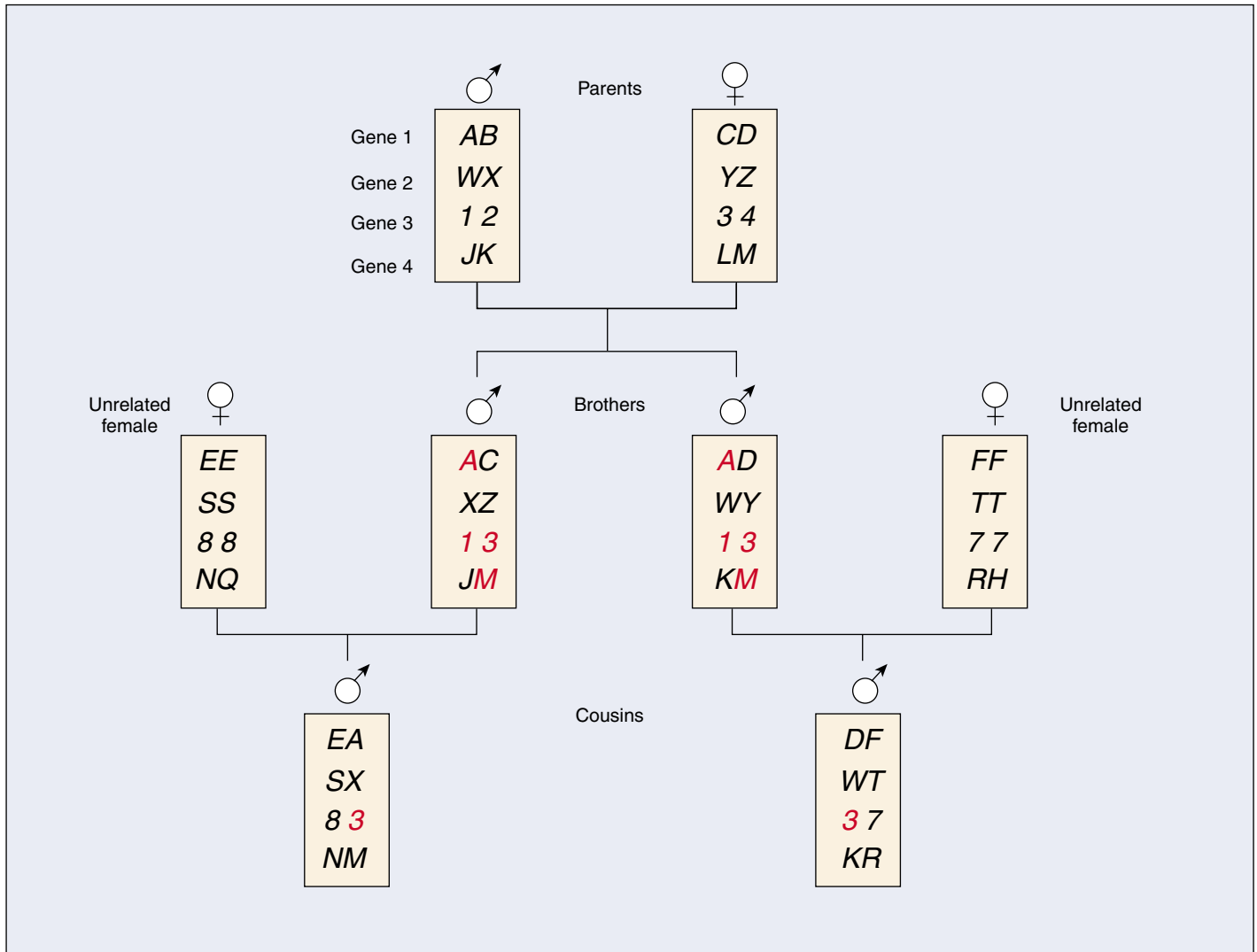

FIGURE 27.11

Hypothetical example of genetic relationship. On average, full siblings will share half of their alleles. By contrast, cousins will, on average, only share one-eighth of their alleles.

Hamilton showed that by directing aid toward kin, or close genetic relatives, an altruist may increase the reproductive success of its relatives enough to compensate for the reduction in its own fitness. Because the altruist's behavior increases the propagation of alleles in relatives, it will be favored by natural selection. Selection that favors altruism directed toward relatives is called **kin selection**. Although the behaviors being favored are cooperative, the genes are actually "behaving selfishly," because they encourage the organism to support copies of themselves in other individuals.

Hamilton's kin selection model predicts that altruism is likely to be directed toward close relatives. The more closely related two individuals are, the greater the poten-

tial genetic payoff. This relationship is described by **Hamilton's rule**, which states that altruistic acts are favored when $b/c > 1/r$. In this expression, b and c are the benefits and costs of the altruistic act, respectively, and r is the coefficient of relatedness, the proportion of alleles shared by two individuals through common descent. For example, an individual should be willing to have one less child if such actions allow a half-sibling, which shares one-quarter of its genes, to have more than four additional offspring.

Many factors could be responsible for the evolution of altruistic behaviors.

Examples of Kin Selection

Many examples of kin selection are known from the animal world. For example, Belding's ground squirrel give alarm calls when they spot a predator such as a coyote or a badger. Such predators may attack a calling squirrel, so giving a signal places the caller at risk. The social unit of a ground squirrel colony consists of a female and her daughters, sisters, aunts, and nieces. Males in the colony are not genetically related to these females. By marking all squirrels in a colony with an individual dye pattern on their fur and by recording which individuals gave calls and the social circumstances of their calling, researchers found that females who have relatives living nearby are more likely to give alarm calls than females with no kin nearby. Males tend to call much less frequently as would be expected as they are not related to most colony members.

Another example of kin selection comes from a bird called the white-fronted bee-eater which lives along rivers in Africa in colonies of 100 to 200 birds. In contrast to the ground squirrels, it is the males that usually remain in the colony in which they were born, and the females that disperse to join new colonies. Many bee-eaters do not raise their own offspring, but rather help others. Many of these birds are relatively young, but helpers also include older birds whose nesting attempts have failed. The presence of a single helper, on average, doubles the number of offspring that survive. Two lines of evidence support the idea that kin selection is important in determining helping behavior in this species. First, helpers are usually males, which are usually related to other birds in the colony, and not females, which are not related. Second, when birds have the choice of helping different parents, they almost invariably choose the parents to which they are most closely related.

Haplodiploidy and Hymenopteran Social Evolution

Probably the most famous application of kin selection theory has been to social insects. A hive of honeybees consists of a single queen, who is the sole egg-layer, and up to 50,000 of her offspring, nearly all of whom are female workers with nonfunctional ovaries (figure 27.12), a situation termed **eusociality**. The sterility of the workers is altruistic: these offspring gave up their personal reproduction to help their mother rear more of their sisters.

Hamilton explained the origin of altruism in hymenopterans (that is, bees, wasps, and ants) with his kin selection model. In these insects, males are haploid and females are diploid. This unusual system of sex determination, called **haplodiploidy**, leads to an unusual situation. If the queen is fertilized by a single male, then all



FIGURE 27.12
Reproductive division of labor in honeybees. The queen (shown here with a red spot painted on her thorax) is the sole egg-layer. Her daughters are sterile workers.

female offspring will inherit exactly the same alleles from their father (because he is haploid and has only one copy of each allele). These female offspring will also share among themselves, on average, half of the alleles they get from the queen. Consequently, each female offspring will share on average 75% of her alleles with each sister (to verify this, rework figure 27.11, but allow the father to only have one allele for each gene). By contrast, should she have offspring of her own, she would only share half of her alleles with these offspring (the other half would come from their father). Thus, because of this close genetic relatedness, *workers propagate more alleles by giving up their own reproduction to assist their mother in rearing their sisters, some of whom will be new queens and start new colonies and reproduce.* Thus, this unusual haplodiploid system may have set the stage for the evolution of eusociality in hymenopterans and, indeed, such systems have evolved as many as 12 or many times in the Hymenoptera.

One wrinkle in this theory, however, is that eusocial systems have evolved in several other groups, including thrips, termites, and naked mole rats. Although thrips are also haplodiploid, both termites and naked mole rats are not. Thus, although haplodiploidy may have facilitated the evolution of eusociality, it is not a necessary prerequisite.

Kin selection is a potent force favoring, in some situations, the evolution of altruism and even complex social systems.

Group Living and the Evolution of Social Systems

Organisms as diverse as bacteria, cnidarians, insects, fish, birds, prairie dogs, lions, whales, and chimpanzees exist in social groups. To encompass the wide variety of social phenomena, we can broadly define a society as *a group of organisms of the same species that are organized in a cooperative manner*.

Why have individuals in some species given up a solitary existence to become members of a group? We have just seen that one explanation is kin selection: groups may be composed of close relatives. In other cases, individuals may benefit directly from social living. For example, a bird that joins a flock may receive greater protection from predators. As flock size increases, the risk of predation decreases because there are more individuals to scan the environment for predators (figure 27.13). A member of a flock may also increase its feeding success if it can acquire information from other flock members about the location of new, rich food sources. In some predators, hunting in groups can increase success and allow the group to tackle prey too large for any one individual.

Insect Societies

In insects, sociality has chiefly evolved in two orders, the Hymenoptera (ants, bees, and wasps) and the Isoptera (termites), although a few other insect groups include social species. All ants, some bees, some wasps, and all termites are **eusocial** (truly social): they have a division of labor in reproduction (a fertile queen and sterile workers), cooperative care of brood and an overlap of generations so that the queen lives alongside her offspring. Social insect colonies are composed of different **castes** of workers that differ in size and morphology and have different tasks they perform, such as workers and soldiers.

In honeybees, the queen maintains her dominance in the hive by secreting a pheromone, called “queen substance,” that suppresses development of the ovaries in other females, turning them into sterile workers. Drones (male bees) are produced only for purposes of mating. When the colony grows larger in the spring, some members do not receive a sufficient quantity of queen substance, and the colony begins preparations for swarming. Workers make several new queen chambers, in which new queens begin to develop. Scout workers look for a new nest site and communicate its location to the colony. The old queen and a swarm of female workers then move to the new site. Left behind, a new queen emerges, kills the

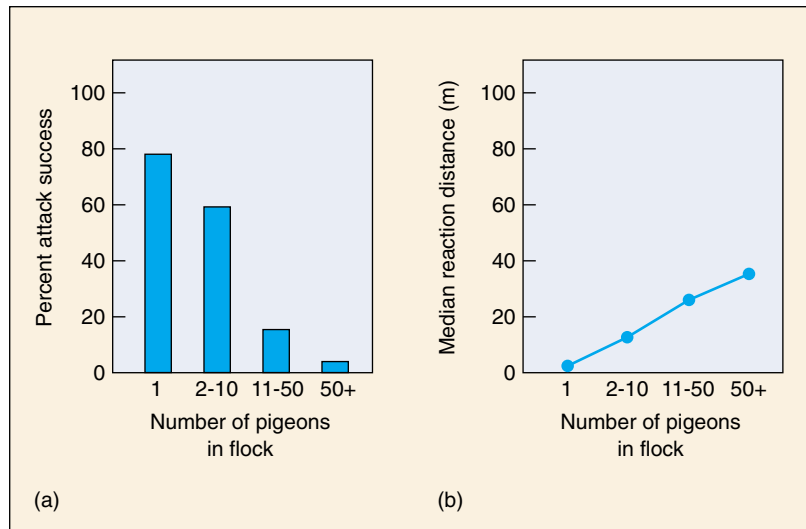

FIGURE 27.13

Flocking behavior decreases predation. (a) As the size of a pigeon flock increases, hawks are less successful at capturing pigeons. (b) When more pigeons are present in the flock, they can detect hawks at greater distances, thus allowing more time for the pigeons to escape.

other potential queens, flies out to mate, and returns to assume “rule” of the hive.

The leafcutter ants provide another fascinating example of the remarkable lifestyles of social insects. Leafcutters live in colonies of up to several million individuals, growing crops of fungi beneath the ground. Their mound-like nests are underground “cities” covering more than 100 square meters, with hundreds of entrances and chambers as deep as 5 meters beneath the ground. The division of labor among the worker ants is related to their size. Every day, workers travel along trails from the nest to a tree or a bush, cut its leaves into small pieces, and carry the pieces back to the nest. Smaller workers chew the leaf fragments into a mulch, which they spread like a carpet in the underground fungus chambers. Even smaller workers implant fungal hyphae in the mulch. Soon a luxuriant garden of fungi is growing. While other workers weed out undesirable kinds of fungi, nurse ants carry the larvae of the nest to choice spots in the garden, where the larvae graze. This elaborate social system has evolved to produce reproductive queens that will disperse from the parent nest and start new colonies, repeating the cycle.

Eusocial insect workers exhibit an advanced social structure that includes division of labor in reproduction and workers with different tasks.

27.4 Vertebrates exhibit a broad range of social behaviors.

Vertebrate Societies

In contrast to the highly structured and integrated insect societies and their remarkable forms of altruism, vertebrate social groups are usually less rigidly organized and cohesive. It seems paradoxical that vertebrates, which have larger brains and are capable of more complex behaviors, are generally less altruistic than insects. Nevertheless, in some complex vertebrate social systems individuals may be exhibiting both reciprocity and kin-selected altruism. But vertebrate societies also display more conflict and aggression among group members than do insect societies. Conflict in vertebrate societies generally centers on access to food and mates.

Vertebrate societies, like insect societies, have particular types of organization. Each social group of vertebrates has a certain size, stability of members, number of breeding males and females, and type of mating system. Behavioral ecologists have learned that the way a group is organized is influenced most often by ecological factors such as food type and predation (figure 27.14).

African weaver birds, which construct nests from vegetation, provide an excellent example to illustrate the relationship between ecology and social organization. Their roughly 90 species can be divided according to the type of social group they form. One set of species lives in the forest and builds camouflaged, solitary nests. Males and females are monogamous; they forage for insects to feed their young. The second group of species nests in colonies in trees on the savanna. They are polygynous and feed in flocks on seeds. The feeding and nesting habits of these two sets of species are correlated with their mating systems. In the forest, insects are hard to find, and both parents must cooperate in feeding the young. The camouflaged nests do not call the attention of predators to their brood. On the open savanna, building a hidden nest is not an option. Rather, savanna-dwelling weaver birds protect their young from predators by nesting in trees which are not very abundant. This shortage of safe nest sites means that birds must nest together in colonies. Because seeds occur abundantly, a female can acquire all the food needed to rear young without a male's help. The male, free from the duties of parenting, spends his time courting many females—a polygynous mating system.

One exception to the general rule that vertebrate societies are not organized like those of insects is the naked mole rat, a small, hairless rodent that lives in and near East Africa. Unlike other kinds of mole rats, which live alone or in small family groups, naked mole rats form large underground colonies with a far-ranging system of tunnels and a central nesting area. It is not unusual for a colony to contain 80 individuals.



FIGURE 27.14
Foraging and predator avoidance. A meerkat sentinel on duty. Meerkats, *Suricata suricata*, are a species of highly social mongoose living in the semiarid sands of the Kalahari Desert. This meerkat is taking its turn to act as a lookout for predators. Under the security of its vigilance, the other group members can focus their attention on foraging.

Naked mole rats feed on bulbs, roots and tubers, which they locate by constant tunneling. As in insect societies, there is a division of labor among the colony members, with some mole rats working as tunnelers while others perform different tasks, depending upon the size of their body. Large mole rats defend the colony and dig tunnels.

Naked mole rat colonies have a *reproductive* division of labor similar to the one normally associated with the eusocial insects. All of the breeding is done by a single female or “queen,” who has one or two male consorts. The workers, consisting of both sexes, keep the tunnels clear and forage for food.

Social behavior in vertebrates is often characterized by kin-selected altruism. Altruistic behavior is involved in cooperative breeding in birds and alarm-calling in mammals.

Human Sociobiology

As a social species, humans have an unparalleled complexity. Indeed, we are the only species with the intelligence to contemplate the social behavior of other animals. Intelligence is just one human trait. If an ethologist were to take an inventory of human behavior, he or she would list kin-selected altruism; reciprocity and other elaborate social contracts; extensive parental care; conflicts between parents and offspring; violence and warfare; infanticide; a variety of mating systems, including monogamy, polygyny, and polyandry; along with sexual behaviors such as extra-pair copulation (“adultery”) and homosexuality; and behaviors like adoption that appear to defy evolutionary explanation. This incredible variety of behaviors occurs *in one species*, and any trait can change within *any individual*. Are these behaviors rooted in human biology?

Biological and Cultural Evolution

During the course of human evolution and the emergence of civilization, two processes have led to adaptive change. One is **biological evolution**. We have a primate heritage, reflected in the extensive amount of genetic material we share with our closest relatives, the chimpanzees. Our upright posture, bipedal locomotion, and powerful, precise hand grips are adaptations whose origins are traceable through our primate ancestors. Kin-selected and reciprocal altruism, as well as other shared traits like aggression and different types of mating systems, can also be seen in nonhuman primates, in whom we can demonstrate that these social traits are adaptive. We may speculate, based on various lines of evidence, that similar traits evolved in early humans. If individuals with certain social traits had an advantage in reproduction over other individuals that lacked the traits, and if these traits had a genetic basis, then the alleles for their expression would now be expected to be part of the human genome and to influence our behavior.

The second process that has underscored the emergence of civilization and led to adaptive change is **cultural evolution**, the transfer across generations of information necessary for survival. This is a nongenetic mode of adaptation. Many adaptations—the use of tools, the formation of cooperative hunting groups, the construction of shelters, and marriage practices—do not follow Mendelian rules of inheritance and are passed from generation to generation by *tradition*. Nonetheless, cultural inheritance is as valid a way to convey adaptations across generations as genetic inheritance. Human cultures are also extraordinarily diverse. The ways in which children are socialized among Trobriand Islanders, Pygmies, and Yanomamo In-

dians are very different. Again, we must remember that this fantastic variation occurs within one species, and that individual behavior is very flexible.

Identifying the Biological Components of Human Behavior

Given this great flexibility, how can the biological components of human behavior be identified? One way is to look for common patterns that appear in a wide variety of cultures, that is, to study behaviors that are cross-cultural. In spite of cultural variation, there are some traits that characterize all human societies. For example, all cultures have an incest taboo, forbidding marriages between close relatives. Incestuous matings lead to a greater chance of exposing disorders such as mental retardation and hemophilia. Natural selection may have acted to create a behavioral disposition against incest, and that disposition is now a cultural norm. Genes responsible for guiding this behavior may have become fixed in human populations because of their adaptive effects. Genes thus guide the direction of culture.

Although human mating systems vary, polygyny is found to be the most common among all cultures. Because most mammalian species are polygynous, the human pattern seems to reflect our mammalian evolutionary heritage and thus is a part of our biology. This conclusion is drawn from using the comparative approach, common in evolutionary science. Nonverbal communication patterns, like smiling and raising the hand in a greeting, also occur in many cultures. Perhaps these behaviors represent a common human heritage.

The explanations sociobiology offers to understand human behavior have been and continue to be controversial. For example, the new discipline of **evolutionary psychology** seeks to understand the origins of the human mind. Human behaviors are viewed as being extensions of our genes. The diversity of human cultures are thought to have a common core of characteristics that are generated by our psychology, which evolved as an adaptation to the lifestyle of our hunter-gatherer ancestors during the Pleistocene. Much of human behavior is seen as reflecting ancient, adaptive traits, now expressed in the context of modern civilization. In this controversial view, human behaviors such as jealousy and infidelity are viewed as adaptations; these behaviors increased the fitness of our ancestors, and thus are now part of the human psyche.

Sociobiology offers general explanations of human behavior that are controversial, but are becoming more generally accepted than in the past.

**Summary****Questions****Media Resources****27.1 Evolutionary forces shape behavior.**

- Many behaviors are ecologically important and serve as adaptations.
- Foraging and territorial behaviors have evolved because they allow animals to use resources efficiently.

1. What does optimal foraging theory predict about an animal's foraging behavior? What factors unrelated to this theory may also influence an animal's foraging choices?

2. What are the benefits of territorial behavior, and what are its costs? Under what circumstances is territorial behavior disadvantageous?

27.2 Reproductive behavior involves many choices influenced by natural selection.

- Male and female animals maximize their fitness with different reproductive behaviors. The differences relate to the extent to which each sex provides care for offspring.
- Usually, males are competitive and females show mate choice because females have higher reproductive costs.
- A species' mating system is related to its ecology.

3. Why does natural selection favor mate choice? What factor is most important in determining which sex exhibits mate choice?

4. In birds, how does the amount of parental care required by the offspring affect the evolution of a species' mating system?



- Bioethics Case Study: Behavior Disordered Students
- On Science Article: Repetition and Learning
- On Science Article: Flipper, A Senseless Killer?

27.3 There is considerable controversy about the evolution of social behavior.

- Many animals show altruistic, or self-sacrificing, behavior. Altruism may evolve through reciprocity or be directed toward relatives. Cooperative behavior often increases an individual's inclusive fitness.
- Individuals form social groups because it is advantageous for them to do so.
- The benefits of living in a group, such as enhanced feeding success, are often balanced by the cost of increased incidence of disease and parasitism.
- Animal societies are characterized by cooperation and conflict. The organization of a society is related to the ecology of a species.

5. What is reciprocal altruism? What is kin selection? How does kin selection increase an individual's success in passing its genes on to the next generation?

27.4 Vertebrates exhibit a broad range of social behaviors.

- Human behavior is extremely rich and varied and may result from both biology and culture.
- Evolutionary theory can give us important insight into human nature, but such an approach to the study of human behavior may have political consequences.

6. In vertebrate societies, what are the costs to an individual who makes an alarm call? Based on research in ground squirrels, which individuals are most likely to make alarm calls, and what benefits do they receive by doing so?